



Siargo Ltd.



Model FS1015CL

SIARGO MEMS FLOW SENSING PRODUCTS
MEMS Mass Flow Sensors

VA.12



© 2017 Siargo Ltd.



Siargo Ltd.

MEMS Mass Flow Sensors

FS1015CL Series

User Manual

Document No. 12-2017-S1 EN

Issue date: 2017.12

Revision: VA.12

Siargo Ltd.

3100 De La Cruz Boulevard,
Suite 210,
Santa Clara, CA 95054
USA

Tel: +1(408)969.0368

Email: info@siargo.com

© Copyright 2017 by Siargo Ltd.

Siargo Ltd. and its subsidiaries reserve the rights to change the specifications and/or descriptions without prior notice. For further information and updates, please visit:

www.Siargo.com

MEMS Mass Flow Sensors



Siargo Ltd.

Model FS1015CL

Features

- Mass flow range: 0 ~ 100 SLPM, 0 ~ 150 SLPM
- Fast response time: 8 ms (max.)
- Highly sensitive in small flow rate
- Low power consumption
- Specially designed for medical equipment
- Small form factor



Description

The FS1015CL mass flow sensors are manufactured using Siargo's proprietary MEMS flow sensor and package technology. The sensors are specially designed for the application of medical equipment such as ventilators for flow monitoring and control with two flow rate ranges of 0 ~ 100 SLPM and 0 ~ 150 SLPM, respectively. The compact package design enables a large dynamic flow range with a pressure drop of 1300 Pa (about 13 cmH₂O) typically. This package withstands a maximum pressure of 0.2 MPa (29 psi) without compromising performance. The mechanical interface is the standard ISO 15 mm medical connection that allows the sensor to be readily applied to ventilators and anesthesia equipment.

The FS1015CL requires a power supply of 5 Vdc and provides a linearized analog output of 0.5 to 4.5 Vdc corresponding with flow rate from 0 to full scale. It also

provides a digital interface through I²C allowing customers to store and retrieve calibration data or other relevant information. The AMP compatible mechanical connector provides reliable connection.

The response time of the FS1015CL is less than 8 ms, which allows customers to monitor instant flow rate variations.

The calibration is generally performed with air at 20 °C and 101.325 kPa pressure rating. It can nonetheless be carried out with other gases and conditions upon requests.

The sensors can be sterilized in medical liquids for reuse or hygienic purposes. The sensors can also be applied for various clean gas measurement with low cost and easy installation. They can be used as a good alternative to volumetric and/or differential pressure type flow sensors.

Working Principle

The MEMS sensor chip utilizes the calorimetric principle. It is packaged on a plate installed inside the flow channel, which provides additional flow conditioning from the boundary layer configuration resulting in a laminar flow. The mass flow measurement is established as the gas carries heat away from the heater leading to the redistribution of the temperature field. Accurate flow rate is obtained by calibration with standard gas at preset conditions.

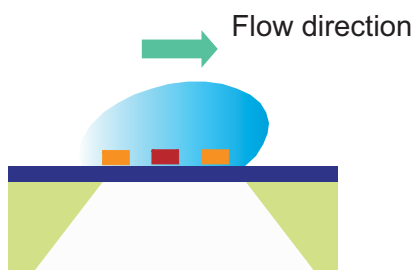

Time-averaged velocity profile boundary layer

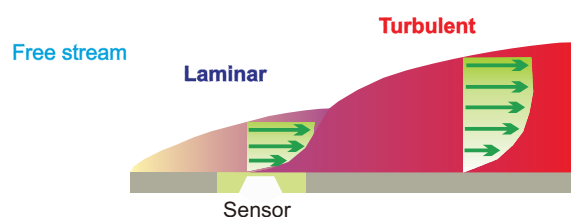

Block Diagram

The functional block diagram is shown in the following figure. The critical component of the FS1015CL is the MEMS sensor chip that is heavily framed in the figure. It is powered by the sensor driving circuitry and sends

flow rate related voltage to ADC. The microcontroller processes (amplifies, filters, etc) the voltage then converts into flow rate. The flow rate signal is sent out through analog format.

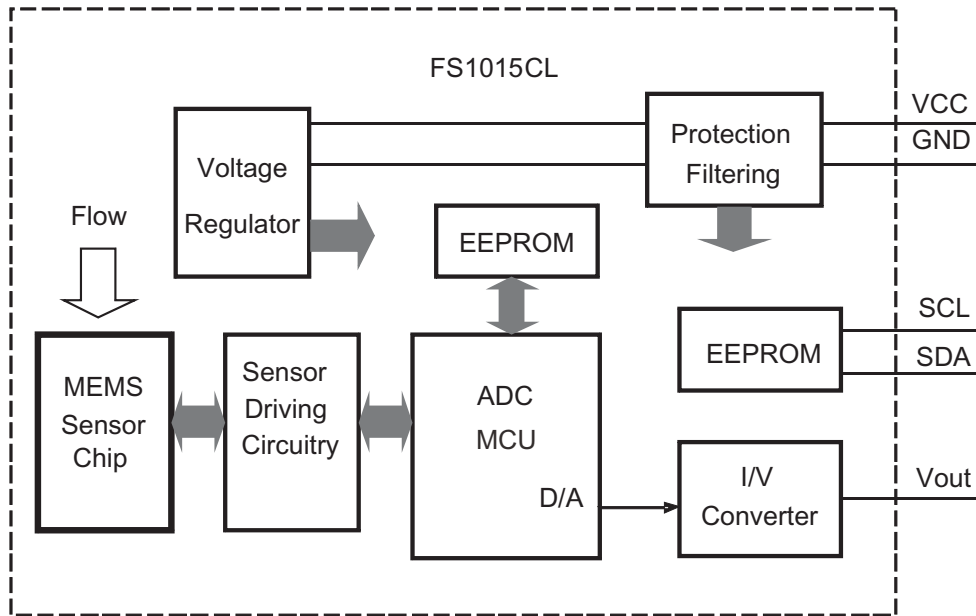

Functional block diagram of the FS1015CL.



1. Sensor Performance

1.1 Performance Specifications

All data unless otherwise noted apply for calibration conditions: air, 20 °C, 101.325 kPa absolute pressure, horizontal mounting.

| Spec | Value | Unit |
|---------------------------------|------------------------------|----------|
| Flow Range | 0 ~ 100; 0 ~ 150 | SLPM |
| Turn-down Ratio | > 100 : 1 | |
| Accuracy ¹ | ± (2.0 + 0.5 FS) | % |
| Repeatability | ± 0.5 | %Reading |
| Null Shift | ± 30 | mV |
| Output Shift | ± 0.12 | %/°C |
| Response Time | 8 (max.) | ms |
| Output ² | Linear, Analog 0.5 ~ 4.5 Vdc | |
| Max. Pressure Drop ³ | 1300 Typ. | Pa |
| Max. Operation Pressure | 0.2 | MPa |
| Power Supply ⁴ | 5 ± 5 % | Vdc |
| Operating Current | < 10 (no output load) | mA |
| Power Consumption | < 50 | mW |
| Analog Output Load | Sourcing: 25 Sinking: 15 | mA |
| Working Temperature | -10 ~ +55 | °C |
| Maximum Overflow | 300 | SLPM |
| Maximum Flow Change | 40 | SLPM/sec |

1 Denotes ±(2.0% Reading + 0.5% Full Scale). To obtain accurate flow measurement, let the sensor warm up 1 minute at power up.

2 The analog output provides linearized voltage of 0.5 ~ 4.5 Vdc corresponding with flow rate of 0 ~ full scale. There is an I²C interface that is for customers to store and access sensor related data.

3 The maximum pressure drop is measured at 150 SLPM. For pressure drop at 100 SLPM, see section 1.4 for details.

4 One 5 Vdc power supply with an accuracy of ±5% is necessary. The minimum supply current must be larger than 10mA.

1.2 Additional Specifications

| | | |
|----------------------------------|-------------------------------------|-----------------|
| Mechanical Connection | ISO - 15 mm | |
| Pins Out ¹ | 5 Pins, NS-TECH CD R-5 | |
| Calibration Options ² | Air @ 20 °C, 101.325 kPa | |
| Dimension | 70.0 x 44.3 x 25.2 | mm ³ |
| Weight | 21.5 | g |
| Storage Temperature | -20 ~ +65 | °C |
| Humidity | < 95 %RH (No icing or condensation) | |

1 The 0.5m output connecting cable (part number: SN5-50) is shipped with the sensor.

2 The sensor is normally calibrated with air at 20 °C and 101.325 kPa pressure rating. Calibrations at other gases and conditions available upon request.

Compliance Statement: All components of this product are RoHS compliant. The product fully complies with CE norm EN61000-6-1 through 61000-6-4 and EMC directive 2014/30/EU.



1.3 Flow Characteristics

The FS1015CL provides an analog output of 0.5 ~ 4.5 Vdc corresponding with 0 ~ full scale flow rate. Using full scale 100 SLPM as an example, the nominal analog output v.s. flow rate is illustrated in Table 1.1 and Figure 1.1. The data is obtained at 5.0 Vdc supply.

Table 1.1: Nominal output voltage v.s. flow rate.

| Flow Rate (SLPM) | Nominal Voltage (Vdc) |
|------------------|-----------------------|
| 0 | 0.5 |
| 20 | 1.3 |
| 40 | 2.1 |
| 60 | 2.9 |
| 80 | 3.7 |
| 100 | 4.5 |
| 110 | 4.9 * |
| 120 | 4.9 * |

* The maximum analog output is base on power supply. For instance, when the power supply is 4.8 Vdc, the maximum analog output will also be 4.8 Vdc.

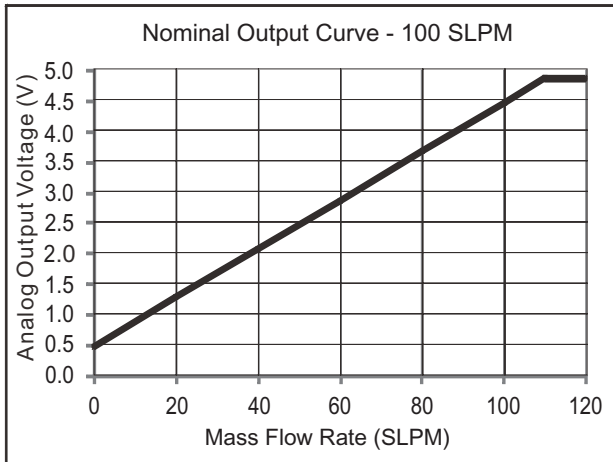

Figure 1.1: The nominal analog output curve of FS1015CL with the full scale of 100 SLPM.

The sensor is calibrated 10% above the full scale flow rate to ensure the accuracy within the defined full range during interpolation. For example, full scale 100 SLPM is calibrated till 110 SLPM. Hence at flow rate beyond the defined full scale, there is still analog output but the accuracy is not guaranteed.

1.4 Pressure Drop Characteristics

The FS1015CL is packaged with a low pressure drop design. The pressure drop is measured throughout the entire measurement range. The results are shown in Table 1.2 and Figure 1.2.

Table 1.2: FS1015CL pressure drop v.s. flow rate.

| Flow Rate (SLPM) | 0 | 50 | 100 | 150 |
|--------------------|---|-----|-----|------|
| Pressure Drop (Pa) | 0 | 200 | 600 | 1300 |

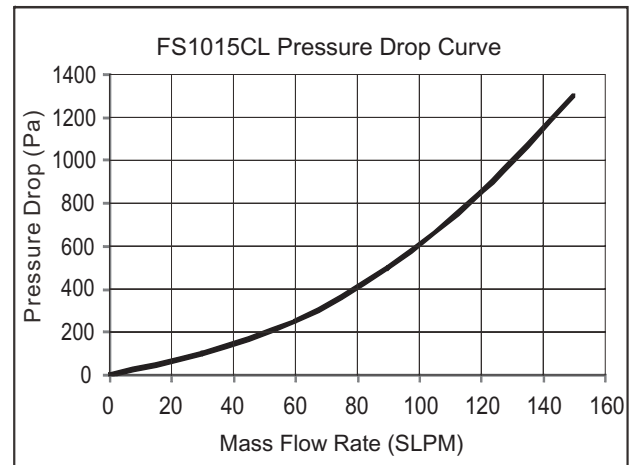

Figure 1.2: FS1015CL pressure drop v.s. flow rate.

2. Electrical Interface

2.1 Pin Definition

The FS1015CL provides a 5-pin interface. The output connecting cable comes with the sensor and it is 0.5m long. The sensor pin layout is shown in Figure 2.1 and the cable color code is defined in Table 2.1.

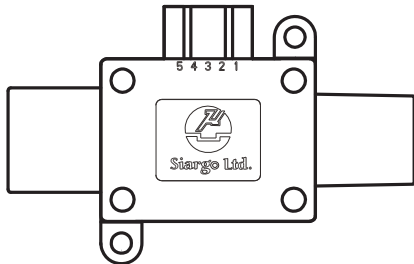

Figure 2.1: FS1015CL pin layout.

Table 2.1: FS1015CL cable color code.

| Pin # | Color | Definition |
|-------|--------|---------------------|
| 1 | Blue | SDA |
| 2 | Green | Vout, Analog output |
| 3 | Red | VCC, Power supply |
| 4 | Black | GND, Ground |
| 5 | Yellow | SCL |

2.2 Pin Description

VCC and **GND**: The FS1015CL requires a power supply of $5 \pm 1\%$ Vdc. The voltage is internally filtered and regulated to power the circuit. The accuracy of the power supply will influence the sensor output and the $\pm 5\%$ accuracy requirement should be met to ensure the specified performance. The sensor consumes less than 10 mA normally and the minimum supply current must be larger than 10 mA.

Vout: The analog output pin provides 0.5 ~ 4.5 Vdc corresponding with the specified flow range 0 ~ full scale. Beyond this range, there is still voltage reading, but the accuracy is not guaranteed.

SDA and **SCL**: The I²C serial communication is provided for storing and accessing sensor-related information, such as calibration data. SDA is the data pin and SCL is the clock pin. For I²C communication protocol, please contact the manufacturer.

3. Mechanical Dimensions and Mountings

3.1 Mechanical Dimensions of ISO-15 Connectors Models

The FS1015CL provides standard ISO-15mm medical connection and can be readily applied to ventilator and anesthesia equipment. The sensor has a total size of 70.0 X 44.3 X 25.2 mm³, the inlet is a male interface and the outlet is a female one. See Figure 3.1 for details.

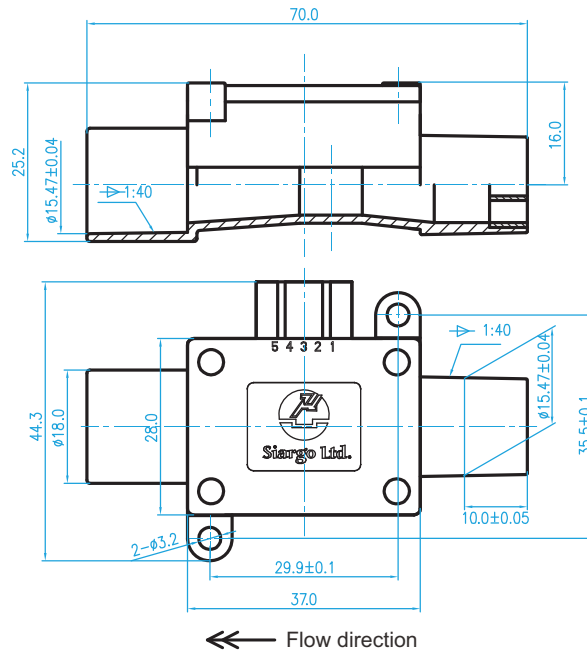

Figure 3.1: The mechanical dimensions of ISO-15 connectors models.

3.2 Mechanical Dimensions of NPT Connectors Models

NPTM 1/2 is selectable for variety of applications. The sensor has a total size of 114.0 X 44.3 X 26.8 mm³, both of the inlet and the outlet interfaces are a male ones. See Figure 3.2 for details.

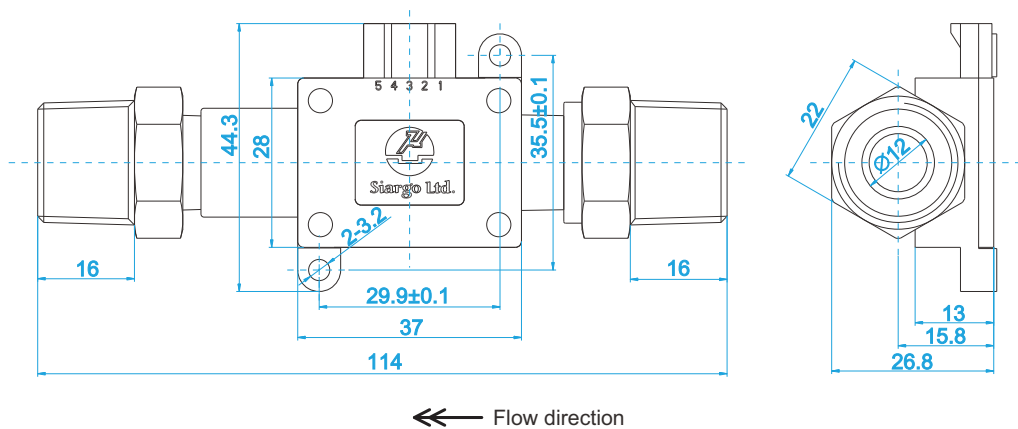

Figure 3.2: The mechanical dimensions of NPT connectors models.



4. Cleaning and Sterilization

The FS1015CL can be sterilized for reuse. The sterilization can be performed with liquid, gas and ultra violet. The liquid sterilization is described as the following.

Immerse the FLOW CHANNEL of the sensor into the sterilizing solution. Make sure the entire sensor body is within the solution but not the electronic cover for 30 min.

Then rinse the sensor by immersing it under DI water

for 30 min. Change with clean DI water for another 30 min.

Dry the sensor in oven at 65 °C for 120 min.

If sterilize with gas or ultra-violet, simply put the sensor in the sterilizing environment for 30 min.

Notice: During sterilization, the sensor must be powered off.

5. Ordering Guide

5.1 Sensor Selection

The sensor part number is composed of the product model number and suffix indicating the full scale flow rate, mechanical connection, output format as well as the application gas. Refer the following for details.

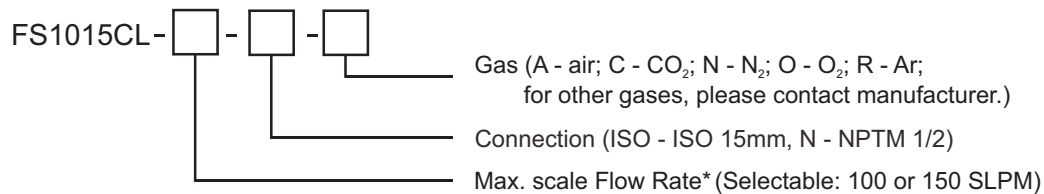

* Max. flow rate number only, for example, 100 meaning full scale flow rate of 100 SLPM;
For CO₂, selectable: 100SLPM (without 150 SLPM).

5.2 Order Contact and Customer Support

The sales offices are listed at the end of this document. For small quantities, the order can be placed either through Siargo website: www.siargo.com or the convenient sales office. For large quantities, please contact the sales office, distributors or sales representatives.

Siargo is making every effort to ensure the quality of the products. In case of questions and/or product supports, please contact customer service listed at the end of the document.



Important Notices

Wetted Materials and Compatibility

The sensor body is made of medical compatible plastics (polycarbonate). The sensor chip comprises of silicon, silicon nitride and silicon dioxide and the sensor chip surfaces are passivated with silicon nitride and silicon dioxide. The electronic sealing is provided by RTV (room temperature vulcanizing) silicone sealant WR-933 composed of $\text{HOCH}_3(\text{SiO})_n\text{CH}_3\text{H}$. Other wetted materials may be exposed are epoxy, gold, copper, FR-4, Pb-free solder.

Compliance Statement

All components of this product are RoHS compliant. The product fully complies with CE norm EN61000-6-1 through 61000-6-4, EN50081-2 through 50082-2 and EMC directive 89/336/EEC.

Cautions for Handling and Installations

The product at the time of shipment is fully inspected for product quality and meets all safety requirements. Additional safety measures during handling and installation should be applied. To prevent ESD (electrostatic discharge) damage and /or degradation, take customary and statutory ESD precautions when handling. Do power the product with the correct polarity, voltage & amperage. All precautions and measures for electrical voltage handling must apply. The product sealing is ensured to work under working pressure of 0.2MPa and is leakage proof before the shipment. But cautions and further leakage test are important at installation as well since any leakage could cause severe safety issue.

This product contains no user serviceable components. Do not attempt to disassemble, substitute parts or perform unauthorized modifications to the product. Doing so will forfeit the terms of the warranty and cause the liability to any damages thereafter. It should only be serviced by authorized personnel. Upon requests, Siargo will provide necessary technical support and/or training of the personnel.

Cautions for Product Applications

The product is designed for use with general purpose gases such as air and nitrogen. It is advised that the products are best used for non-explosive clean gases. The sensors cannot be used for gas metrology of fluoride or fluoride-containing gases. For updates of the product certification information, please contact the manufacturer. Use for other gases such as extreme corrosive and toxic may cause the product malfunctioning or even severe damages.

Don't expose the product's electronics other than the inner flow channel to any liquids, the unit does not have

a water proof electronics. For medical sterilization procedure, please consult the manufacturer. Don't flow gas in conditions that can cause condensing water vapor to be trapped inside the unit during operation as the accuracy could be significantly influenced.

It is suggested to design your application so that nominal flow rate is approximately 70% of the full scale flow rating of the sensor. Don't use a sensor with a flow range at the extreme cases, for instance, don't use a 150 SLPM sensor for a 1.5 SLPM application.

Warranty and Liability

(Effective January 2010)

Siargo warrants the products sold hereunder, properly used and properly installed under normal circumstances and service as described in this user manual, shall be free from faulty materials or workmanship for 180 days for OEM products, and 365 days for non-OEM products from the date of shipment. This warranty period is inclusive of any statutory warranty. Any repair or replacement serviced product shall bear the same terms in this warranty.

Siargo makes no other warranty, express or implied and assumes no liability for any special or incidental damage or charges, including but not limited to any damages or charges due to installation, dismantling, reinstallation or any other consequential or indirect damages of any kind. To the extent permitted by law, the exclusive remedy of the user or purchaser, and the limit of Siargo's liability for any and all losses, injuries or damages concerning the products including claims based on contract, negligence, tort, strictly liability or otherwise shall be the return of products to Siargo, and upon verification of Siargo to prove to be defective, at its sole option, to refund, repair or replacement of the products. No action, regardless of form, may be brought against Siargo more than 365 days after a cause of action has accrued. The products returned under warranty to Siargo shall be at user or purchaser's risk of loss, and will be returned, if at all, at Siargo's risk of loss. Purchasers or users are deemed to have accepted this limitation of warranty and liability, which contains the complete and exclusive limited warranty of Siargo, and it shall not be amended, modified or its terms waived except by Siargo's sole action.

This warranty is subject to the following exclusions:

- (1) Products that have been altered, modified or have been subject to unusual physical or electrical circumstances indicated but not limited to those stated in this document or any other actions which cannot be deemed as proper use of the products;
- (2) Siargo does not provide any warranty on finished goods manufactured by others. Only the original manufacturer's warranty applies;
- (3) Products re-sold to the third parties.



Contact Information

Headquarters

Siargo Ltd.
3100 De La Cruz Boulevard, Suite 210,
Santa Clara, California 95054, USA
Phone: +1-408-969-0368
Email: info@Siargo.com

Representative in US

Servoflo Corporation
75 Allen Street,
Lexington, MA 02421, USA
Phone: +1-781-862-9572
Email: info@servoflo.com

Representative in Japan

Marubeni Information Systems Co., Ltd.
Device Solutions Department
14th Floor, Shinjuku Garden Tower,
3-8-2, Okubo, Shinjuku-ku, Tokyo 169-0072, Japan
Phone: +81-3-4243-4160
Fax: +81-3-4243-4198
Email: siargo@marubeni-sys.com

Representative in Europe

IDENTIC GmbH
In der Siedlerruh 24
69123 Heidelberg / Germany
Phone: +49-(0)6221-7509777
Fax: +49-(0)6221-7509779
Email: info@identic.de

This document is intended for distribution to customer(s) only. Siargo and its subsidiaries reserve the rights to change the specifications and/or descriptions without prior notice.



Appendix: Revision History

Revision A.12 (December 2017):

- ✎ Revised the mechanical dimensions of NPT Connectors (3.2 Mechanical Dimensions of NPT Connectors Models).

Revision A.11 (November 2017):

- ✎ Revised the wetted materials (Wetted Materials and Compatibility).

Revision A.10 (September 2017):

- ✎ Added maximum overflow and maximum flow change (1.1 Performance Specifications);
- ✎ Added the revision history (Appendix).