



Siargo Ltd.



# Model FS6122

SIARGO MEMS FLOW SENSING PRODUCTS

## Integrated Sensors for CPAP Applications

VA.11



© 2019 Siargo Ltd.



Siargo Ltd.

# Integrated MEMS Sensors for CPAP Applications

FS6122 Series

## User Manual

Document No. 10-2019-S9 EN

Issue date: 2019.10

Revision: VA.11

### **Siargo Ltd.**

3100 De La Cruz Boulevard,  
Suite 210,  
Santa Clara, CA 95054  
USA

Tel: +1(408)969.0368

Email: [info@siargo.com](mailto:info@siargo.com)

© Copyright 2019 by Siargo Ltd.

Siargo Ltd. and its subsidiaries reserve the rights to change the specifications and/or descriptions without prior notice. For further information and updates, please visit: [www.Siargo.com](http://www.Siargo.com)

# Integrated MEMS Sensors for CPAP



Siargo Ltd.

## Model FS6122

### 1. Features

- Specially designed for medical CPAP applications
- Direct measurement of mass flow rate and gauge pressure
- Optional humidity and temperature sensors
- Small dead volume with compact form factor
- Digital and analog linear output with fast response time



### 2. Sensor Performance

All data unless otherwise noted apply for calibration conditions: air, 20 °C, 101.325 kPa absolute pressure, horizontal mounting.

|                                          |                             | Vaule                                               | Unit               |
|------------------------------------------|-----------------------------|-----------------------------------------------------|--------------------|
| <b>Flow Sensor</b>                       | Flow Range <sup>1</sup>     | -250 ~ +250                                         | SLPM               |
|                                          | Accuracy (Total Error Band) | ± (2.5 + 0.5FS)                                     | %                  |
|                                          | Output                      | Linear, Analog/I <sup>2</sup> C (14bit)             |                    |
|                                          | Analog Output <sup>2</sup>  | 0.5 ~ 4.5                                           | Vdc                |
|                                          | Response Time               | 1.8                                                 | ms                 |
| <b>Pressure Sensor</b>                   | Pressure Type               | Gauge                                               |                    |
|                                          | Pressure Range              | 0 ~ +40/+100; -5 ~ +40/+100; -40 ~ +40; -100 ~ +100 | cmH <sub>2</sub> O |
|                                          | Total Accuracy              | ± 1.0                                               | %FS                |
|                                          | Output                      | Linear, Analog/I <sup>2</sup> C (14bit)             |                    |
|                                          | Analog Output <sup>2</sup>  | 0.5 ~ 4.5                                           | Vdc                |
|                                          | Response Time               | 1.8                                                 | ms                 |
| <b>Temperature &amp; Humidity sensor</b> | Temperature                 | -10 ~ 60                                            | °C                 |
| <b>Humidity sensor</b>                   | Accuracy                    | ± 0.5                                               | °C                 |
|                                          | Humidity                    | 0~100(No icing or condensation)                     | %RH                |
|                                          | Accuracy                    | ±2.0 (20~80%RH); ±5.0 max (other ranges)            | %RH                |
|                                          | Resolution                  | 0.7                                                 | %RH                |
|                                          | Response time (63%)         | 5.0 (25~75%RH)                                      | sec                |
|                                          | Stability                   | 0.5                                                 | %RH/year           |

#### Other Specifiactions

|                         |                                             |         |
|-------------------------|---------------------------------------------|---------|
| Gas Type                | Air                                         |         |
| Supply Voltage          | 5.0 ± 5%                                    | Vdc     |
| Output Pin <sup>4</sup> | 6 Pins, Cable SN6-50 (NS-TECH CD R-6; 0.5m) |         |
| Compensated Temperature | -5 ~ +65                                    | °C      |
| Compensated Altitude    | -400 ~ +3000 (700 ~ 1060)                   | m (hPa) |
| Storage Temperature     | -40 ~ +85                                   | °C      |
| Warming Up Time         | <50                                         | ms      |

\*Pressure and/or humidity & temperature sensor could be optional, see detailed order information in section 5.

1, Other flow ranges are available, see detailed order information in section 5.

2, Corresponding to the value from reverse full scale to forward full scale.

3, Maximum pressure base on the working pressure of the pressure sensor.

Pressure range: -5 ~ +40 cmH<sub>2</sub>O, proof pressure: ±30 kPa, burst pressure: ±40 kPa.

Pressure range: -5 ~ +100 cmH<sub>2</sub>O, proof pressure: ±80 kPa, burst pressure: ±100 kPa.

4, The connector is OEMed according to the specification (4x6 MTE RCPT SR Latch. 100CL) that is 100% compatible with TE 5-103956-5 (<http://www.te.com/usa-en/product-5-103956-5.html>) any AMPMODU MTE of the same type.



### 3. Performance Characteristics

| Flow Rate (SLPM) | Typical Voltage (Vdc) |
|------------------|-----------------------|
| -250             | 0.500                 |
| -200             | 0.900                 |
| -150             | 1.300                 |
| -100             | 1.700                 |
| -50              | 2.100                 |
| 0                | 2.500                 |
| +50              | 2.900                 |
| +100             | 3.300                 |
| +150             | 3.700                 |
| +200             | 4.100                 |
| +250             | 4.500                 |

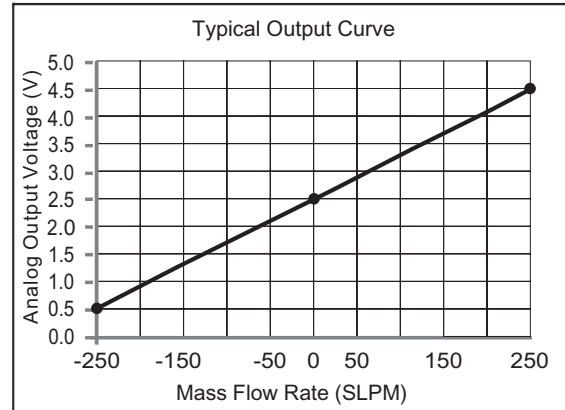

| Pressure (cmH <sub>2</sub> O) | Typical Voltage (Vdc) |
|-------------------------------|-----------------------|
| -5                            | 0.500                 |
| 0                             | 0.944                 |
| +5                            | 1.389                 |
| +10                           | 1.833                 |
| +15                           | 2.278                 |
| +20                           | 2.722                 |
| +25                           | 3.167                 |
| +30                           | 3.611                 |
| +35                           | 4.056                 |
| +40                           | 4.500                 |

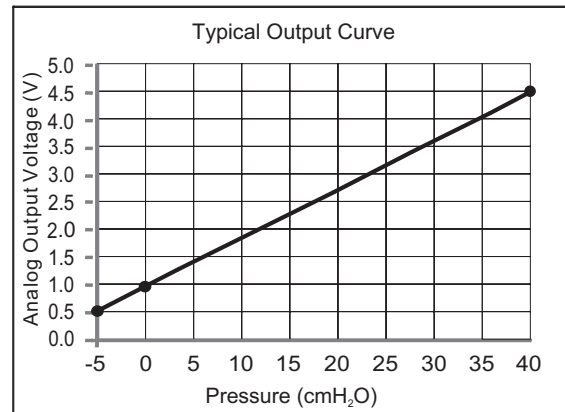

The temperature and humidity data can only be available via the I<sup>2</sup>C interface due to the limited available analog ports.

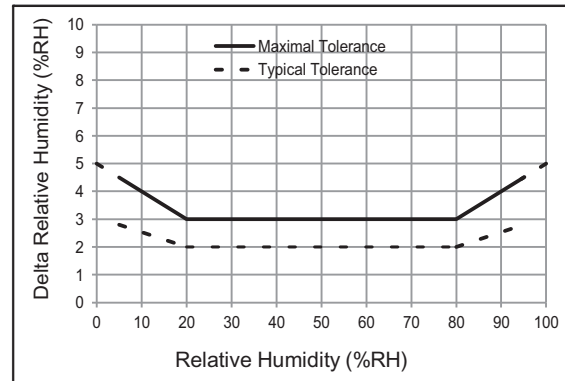

### 4. Pressure loss

The pressure loss was measured at 20°C and 101.325kPa. The pressure loss at the reverse flow beared the identical characteristics.

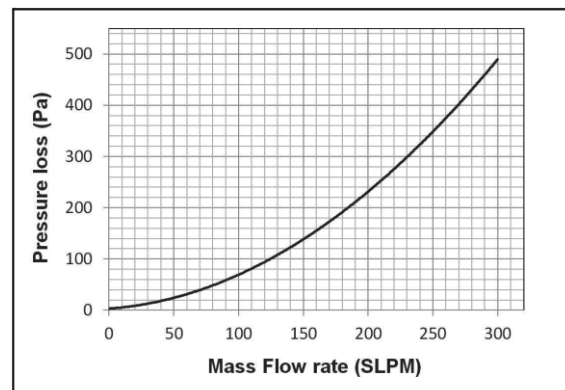

## 5. Electrical Interface

### 5.1 Pin Definition

The FS6122 provides a 6-pin interface. The output connecting cable comes with the sensor. The sensor pin layout is shown in Figure 5.1 and the cable color code is defined in Table 5.1.

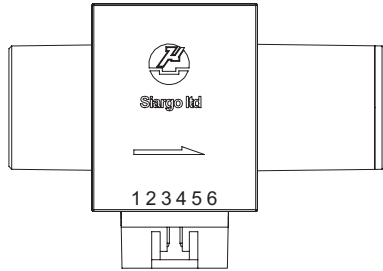

Figure 5.1: FS6122 pin layout.

Table 5.1: FS6122 pin code.

| Pin | Color  | Definition                                        |
|-----|--------|---------------------------------------------------|
| 1   | White  | Pout <sup>1</sup> , Pressure sensor analog output |
| 2   | Green  | Fout, Flow sensor analog output                   |
| 3   | Black  | GND, Ground                                       |
| 4   | Red    | VCC, Power supply                                 |
| 5   | Yellow | SCL (I <sup>2</sup> C)                            |
| 6   | Blue   | SDA (I <sup>2</sup> C)                            |

1, The pressure output can be optional.

### 5.2 Pin Description

**VCC** and **GND**: The FS6122 requires a power supply of 5±5% Vdc. The voltage is internally filtered and regulated to power the circuit. The sensor consumes less than 20 mA normally and the minimum supply current must be larger than 15 mA.

**Pout**: The pressure analog output can be optional. The pin provides 0.5 ~ 4.5 Vdc corresponding with the specified pressure full scale range.

**Fout**: The flow rate analog output. The pin provides 0.5 ~ 4.5 Vdc corresponding with the specified flow full scale range.

**SDA** and **SCL**: Serial data line and serial clock line.

## 6. Product Order Information

### 6.1 Sensor Part Number

The sensor part number is composed of the product model number and suffix indicating the full scale flow rate, pressure rating, and temperature and humidity sensor integration. mechanical connection, output format as well as the application gas. Refer the following for details.

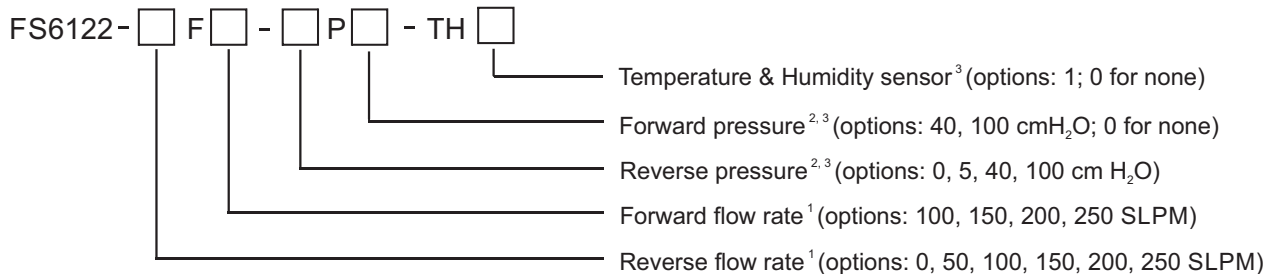

1 Numbers are for full scale flow rate, for example, 250 meaning full scale flow rate of 250SLPM. When reverse flow rate is 0, the sensor shall be configured as an uni-directional flow sensor.

2 Numbers are for full scale pressure, for example, 40 meaning full scale pressure rating of 40 cmH<sub>2</sub>O.  
Optional: 0P40, 0P100, 5P40, 5P100, 40P40, 100P100. 0P0 means no pressure sensor.

3 Pressure sensor, temperature sensor and humidity sensor are optional, "-0P0-TH0" means flow sensing only models.

4 For instance, FS6122-50F200-5P40-TH1, means flow rate of -50 to +200 SLPM, pressure rating of -5 to +40 cmH<sub>2</sub>O and temperature and humidity sensors are integrated.

## 6.2 Order Contact and Customer Support

The sales offices are listed at the end of this document. For small quantities, the order can be placed either through Siargo website: [www.siargo.com](http://www.siargo.com) or the convenient sales office. For large quantities, please contact the sales office, distributors or sales representatives.

Siargo is making every effort to ensure the quality of the products. In case of questions and/or product supports, please contact customer service listed at the end of the document.

## 7. Mechanical Dimensions

The FS6122 provides standard ISO-22mm medical connection and can be plug-and-play for CPAP machines. The sensor has a mechanical size of 67 X 47 X 31 mm.

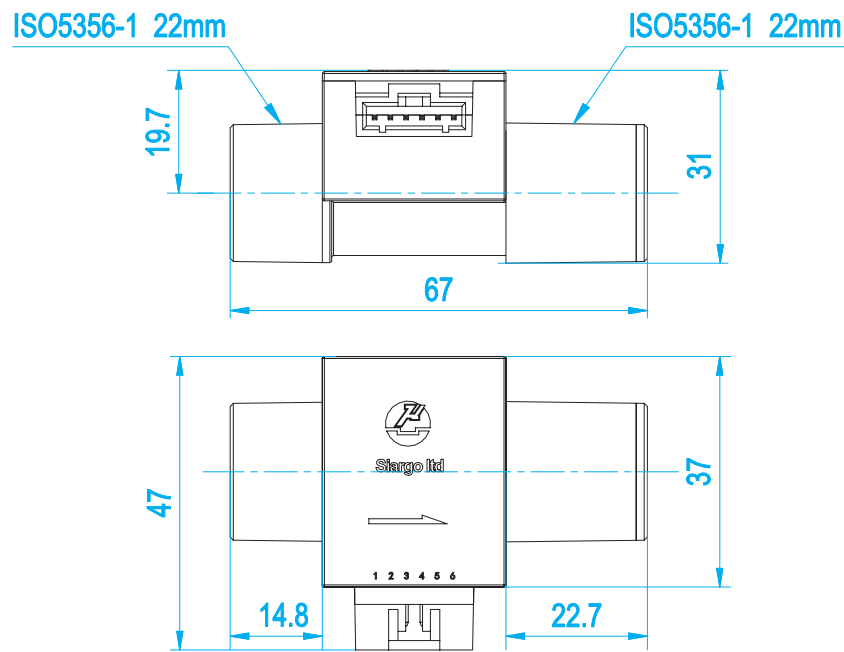

## 8. I<sup>2</sup>C Communication

### 8.1 I<sup>2</sup>C Connection

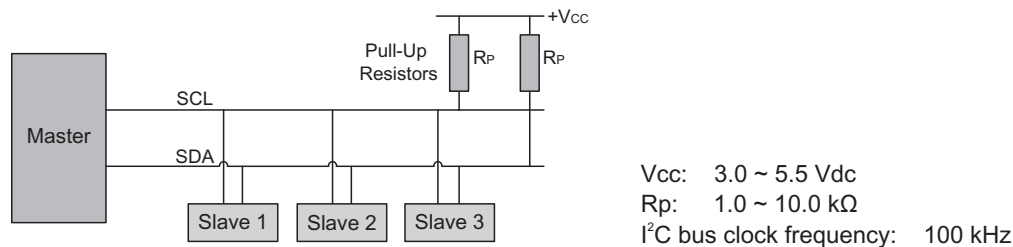

### 8.2 I<sup>2</sup>C Read and Write Sequences

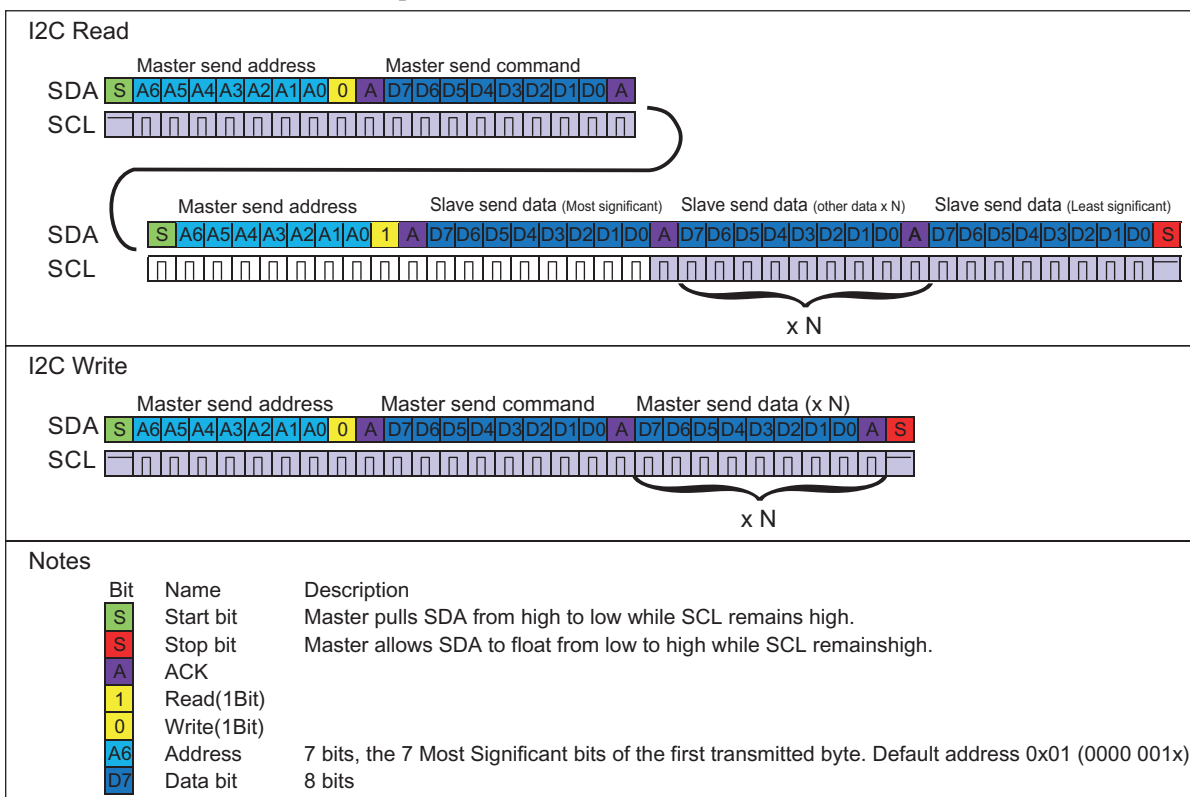

### 8.3 I<sup>2</sup>C Commands description

| Command Byte (Hex) | Length | Command Name                        | Read / Write | Notes                                                |
|--------------------|--------|-------------------------------------|--------------|------------------------------------------------------|
| 05H                | 1      | Write the I <sup>2</sup> C address  | W            | Bit7 ~ Bit1 can be set *                             |
| 0BH                | 1      | Write the filter depth              | W            | Int8, 0~254                                          |
| 1CH                | 1      | Calibration the offset of flow rate | W            | 1 byte, any value, ensure <b>NO</b> flow in the pipe |
| 24H                | 1      | Calibration the offset of pressure  | W            | 1 byte, any value, ensure <b>NO</b> flow in the pipe |
| 82H                | 12     | Read the sensor SN                  | R            | ASCII                                                |
| 83H                | 4      | Read the flow rate                  | R            | Int32/1000 SLPM                                      |
| 84H                | 8      | Read the flow rate and the pressure | R            | Int32/1000 SLPM, Int32/1000 cmH <sub>2</sub> O       |
| 85H                | 1      | Read the I <sup>2</sup> C address   | R            | Bit7 ~ Bit1                                          |
| 8BH                | 1      | Read the filter depth               | R            | Int8, 0~254                                          |
| A3H                | 4      | Read the pressure                   | R            | Int32/1000 cmH <sub>2</sub> O                        |
| B2H                | 2      | Read the temperature                | R            | Int16/100                                            |
| B3H                | 2      | Read the humidity                   | R            | Int16/100 %RH                                        |

\* The address is set with Bit7~Bit1. For instance, sensor I<sup>2</sup>C address 4, write address will be 0x08 (0000 1000), while read address will be 0x09 (0000 1001).



## Important Notices

### Wetted Materials and Compatibility

The sensor body is made of medical compatible plastics (polycarbonate, Covestro Makrolon 2458). The sensor chip comprises of silicon, silicon nitride and silicon dioxide and the sensor chip surfaces are passivated with silicon nitride and silicon dioxide. The electronic sealing is provided by RTV (room temperature vulcanizing) silicone sealant WR-933 composed of  $\text{HOCH}_3(\text{SiO})_n\text{CH}_3\text{H}$ . Other wetted materials may be exposed are Pyrex glass, alumina ceramics, epoxy, gold, aluminum, nickel, FR-4, Pb-free solder.

### Cautions for Handling and Installations

The product at the time of shipment is fully inspected for product quality and meets all safety requirements. Additional safety measures during handling and installation should be applied. To prevent ESD (electrostatic discharge) damage and /or degradation, take customary and statutory ESD precautions when handling. Do power the product with the correct polarity, voltage & amperage. All precautions and measures for electrical voltage handling must apply. The product sealing is ensured to work under working pressure of 30 kPa and is leakage proof before the shipment. But cautions and further leakage test are important at installation as well since any leakage could cause severe safety issue.

This product contains no user serviceable components. Do not attempt to disassemble, substitute parts or perform unauthorized modifications to the product. Doing so will forfeit the terms of the warranty and cause the liability to any damages thereafter. It should only be serviced by authorized personnel. Upon requests, Siargo will provide necessary technical support and/or training of the personnel.

### Cautions for Product Applications

The product is designed for use with general purpose gases such as air and nitrogen. It is advised that the products are best used for non-explosive clean gases. The sensors cannot be used for gas metrology of fluoride or fluoride-containing gases. For updates of the product certification information, please contact the manufacturer. Use for other gases such as extreme corrosive and toxic may cause the product malfunctioning or even severe damages.

Don't expose the product's electronics other than the inner flow channel to any liquids, the unit does not have a water proof electronics. For medical sterilization procedure, please consult the manufacturer. Don't flow gas in conditions that can cause condensing water

vapor to be trapped inside the unit during operation as the accuracy could be significantly influenced.

It is suggested to design your application so that nominal flow rate is approximately 70% of the full scale flow rating of the sensor. Don't use a sensor with a flow range at the extreme cases, for instance, don't use a 200 SLPM sensor for a 2 SLPM application.

### Warranty and Liability

(Effective January 2010)

Siargo warrants the products sold hereunder, properly used and properly installed under normal circumstances and service as described in this user manual, shall be free from faulty materials or workmanship for 180 days for OEM products, and 365 days for non-OEM products from the date of shipment. This warranty period is inclusive of any statutory warranty. Any repair or replacement serviced product shall bear the same terms in this warranty.

Siargo makes no warranty, representation, or guarantee and shall not assume any liability regarding the suitability of the products described in this manual for any purposes that are not specified in this manual. The users shall be held for full responsibility for validating the performance and suitability of the products for their particular design and applications. For any of the misuse of the products out of the scope described herein, the user shall indemnify and hold Siargo and its officers, employees, subsidiaries, affiliates and sales channels harmless against all claims, costs, damages, and expense or reasonable attorney fee from direct or indirect sources.

Siargo makes no other warranty, express or implied and assumes no liability for any special or incidental damage or charges, including but not limited to any damages or charges due to installation, dismantling, reinstallation or any other consequential or indirect damages of any kind. To the extent permitted by law, the exclusive remedy of the user or purchaser, and the limit of Siargo's liability for any and all losses, injuries or damages concerning the products including claims based on contract, negligence, tort, strictly liability or otherwise shall be the return of products to Siargo, and upon verification of Siargo to prove to be defective, at its sole option, to refund, repair or replacement of the products. No action, regardless of form, may be brought against Siargo more than 365 days after a cause of action has accrued. The products returned under warranty to Siargo shall be at user or purchaser's risk of loss, and will be returned, if at all, at Siargo's risk of loss. Purchasers or users are deemed to have accepted this limitation of warranty and liability, which contains the complete and exclusive limited warranty of Siargo, and it shall not be amended, modified or its terms waived except by Siargo's sole action.





The product information provided in this manual is believed to be accurate and reliable at the time of release to or made available to the users. However, Siargo shall assume no responsibility for any inaccuracies and/or errors and reserves the rights to make changes without further notice for the relevant information herein.

This warranty is subject to the following exclusions:

- (1) Products that have been altered, modified or have been subject to unusual physical or electrical circumstances indicated but not limited to those stated in this document or any other actions which cannot be deemed as proper use of the products;
- (2) Siargo does not provide any warranty on finished goods manufactured by others. Only the original manufacturer's warranty applies;
- (3) Products re-sold to the third parties.

## Contact Information

### Headquarters

Siargo Ltd.  
3100 De La Cruz Boulevard, Suite 210,  
Santa Clara, California 95054, USA  
Phone: +1-408-969-0368  
Email: [info@Siargo.com](mailto:info@Siargo.com)

### Representative in US

Servoflo Corporation  
75 Allen Street,  
Lexington, MA 02421, USA  
Phone: +1-781-862-9572  
Email: [info@servoflo.com](mailto:info@servoflo.com)

### Representative in Japan

Marubeni Information Systems Co., Ltd.  
Device Solutions Department  
14th Floor, Shinjuku Garden Tower,  
3-8-2, Okubo, Shinjuku-ku, Tokyo 169-0072, Japan  
Phone: +81-3-4243-4160  
Fax: +81-3-4243-4198  
Email: [siargo@marubeni-sys.com](mailto:siargo@marubeni-sys.com)

### Representative in Europe

IDENTIC GmbH  
In der Siedlerruh 24  
69123 Heidelberg / Germany  
Phone: +49-(0)6221-7509777  
Fax: +49-(0)6221-7509779  
Email: [info@identic.de](mailto:info@identic.de)

This document is intended for distribution to customer(s) only. Siargo and its subsidiaries reserve the rights to change the specifications and/or descriptions without prior notice.



## Appendix: Revision History

### Revision A.11 (October 2019):

- ✎ Updated the output pin information (2. *Sensor Performance*).

### Revision A.10 (October 2018):

- ✎ Updated the pressure ranges (2. *Sensor Performance* and 6.1 *Sensor Part Number*).

### Revision A.9 (April 2018):

- ✎ Revised the I<sup>2</sup>C Sequences and I<sup>2</sup>C Commands description (8.2 *I<sup>2</sup>C Read and Write Sequences* and 8.3 *I<sup>2</sup>C Commands description*).

### Revision A.8 (July 2017):

- ✎ Revised the update time 1.0 ms to response time 1.8 ms for both flow signal and pressure signal (2. *Sensor Performance*);
- ✎ Corrected the sensor body material (*Wetted Materials and Compatibility*);
- ✎ Updated the application cautions (*Cautions for Product Applications*);
- ✎ Updated the contact information of representative in Europe (*Contact Information*);
- ✎ Added the revision history (*Appendix*).